

framery

SERIOUS ABOUT HAPPINESS

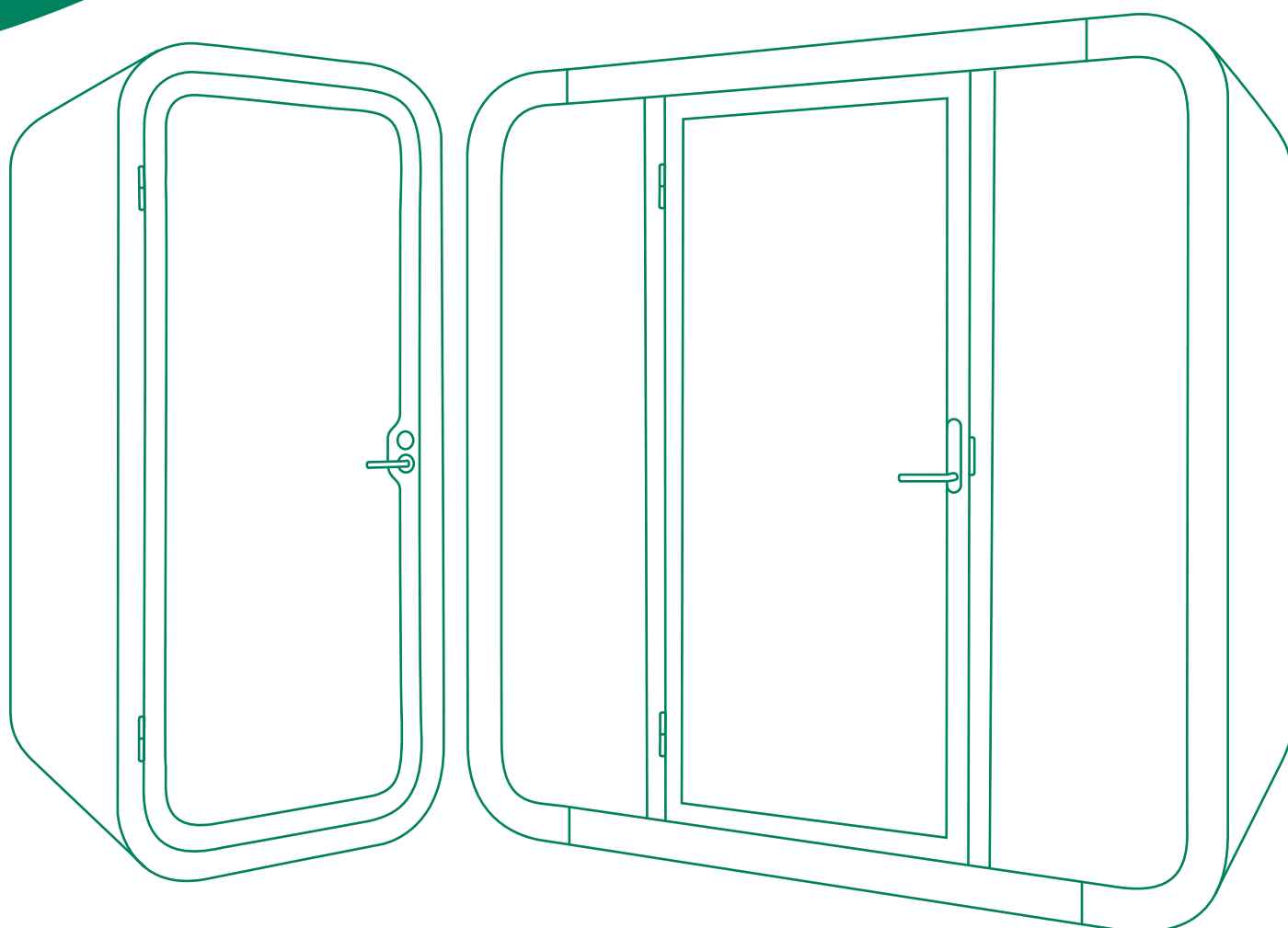

Framery pods
User instructions

English
Version 1.2
Tampere, Finland 10.02.2023

Contents

1 Introduction.....	5
1.1 Preface.....	5
1.2 Manual contents.....	5
1.3 Warning, information, and safety symbols in this manual.....	5
2 Adjusting the seat (Framery O).....	6
3 Adjusting the table height (Framery Q Flow).....	7
4 Using the control panel (Framery Q).....	8
4.1 Adjusting the lights.....	8
4.2 Adjusting the fans.....	9
5 Connecting electrical equipment.....	10
6 Using the wireless charger.....	12
7 Important safety and product instructions.....	14
7.1 Product information.....	14
7.2 Copyright.....	14
7.3 Intended use.....	14
7.3.1 Non-conventional use.....	14
7.3.2 Ambient conditions for use.....	14
7.4 Main safety risks related to the installation, maintenance, disassembly, and use of the product.....	15
7.4.1 Electrical safety.....	15
7.4.2 Use.....	16

1 Introduction

1.1 Preface

This instruction manual describes the use of the product. Everyone involved in using the product must read and understand the contents of the user and safety instructions.

This instruction manual gives you necessary information for the correct use.

1.2 Manual contents

The user instructions contain the following information:

- General information about the purpose and content of the instructions
- Information related to safety
- User instructions

1.3 Warning, information, and safety symbols in this manual

The warnings in this manual have been divided into the following two categories:

- The term "DANGER" indicates a hazardous situation which, if not avoided, will result in death or serious injury.
- The term "WARNING" indicates a hazardous situation which, if not avoided, could result in death or injury.

The safety symbols found in this manual may also be posted on the product. All personnel who install, disassemble, perform maintenance, or use the product are to be familiar with and observe all safety symbols, labels, and instructions about the action they are performing.

Table 1: Hazard



	An exclamation point symbol inside a colored triangle indicates a hazardous situation.
	

Table 2: Mandatory action



	A white symbol inside a colored circle indicates an action that must be taken to avoid a hazardous situation.
---	---

Table 3: Prohibited action

	A ring with a diagonal bar indicates an action that is not allowed.
---	---

2 Adjusting the seat (Framery O)

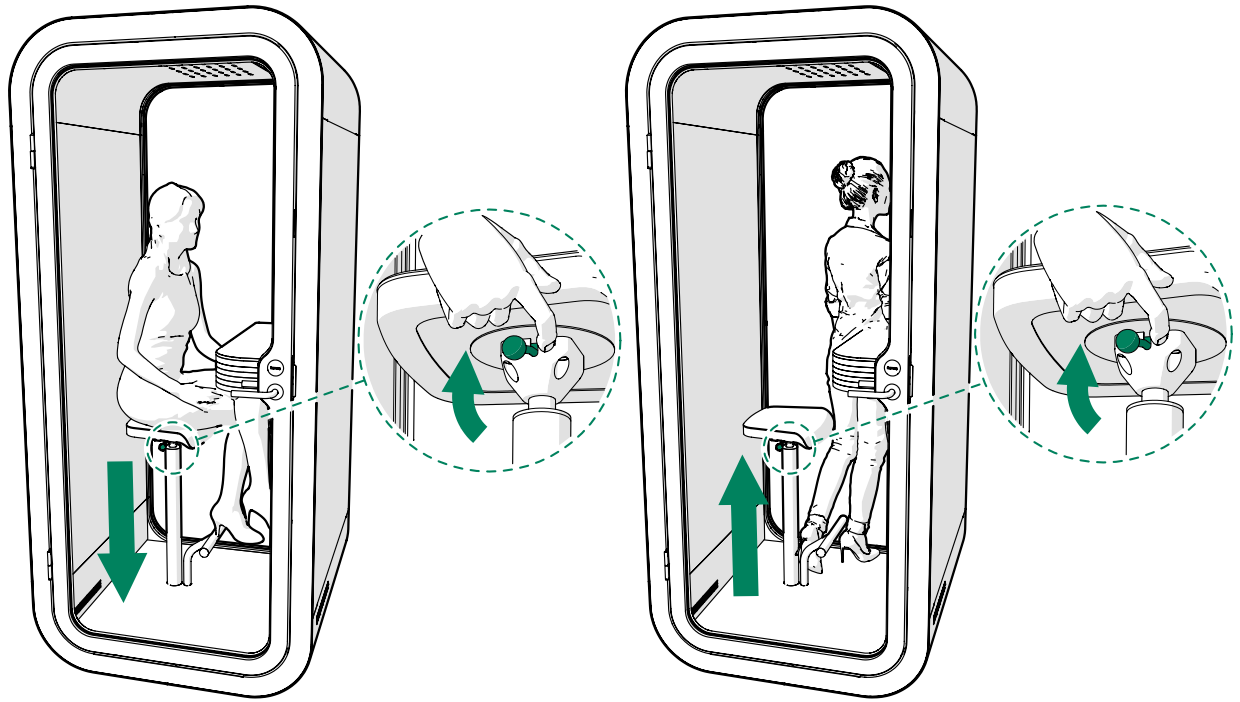

3 Adjusting the table height (Framery Q Flow)

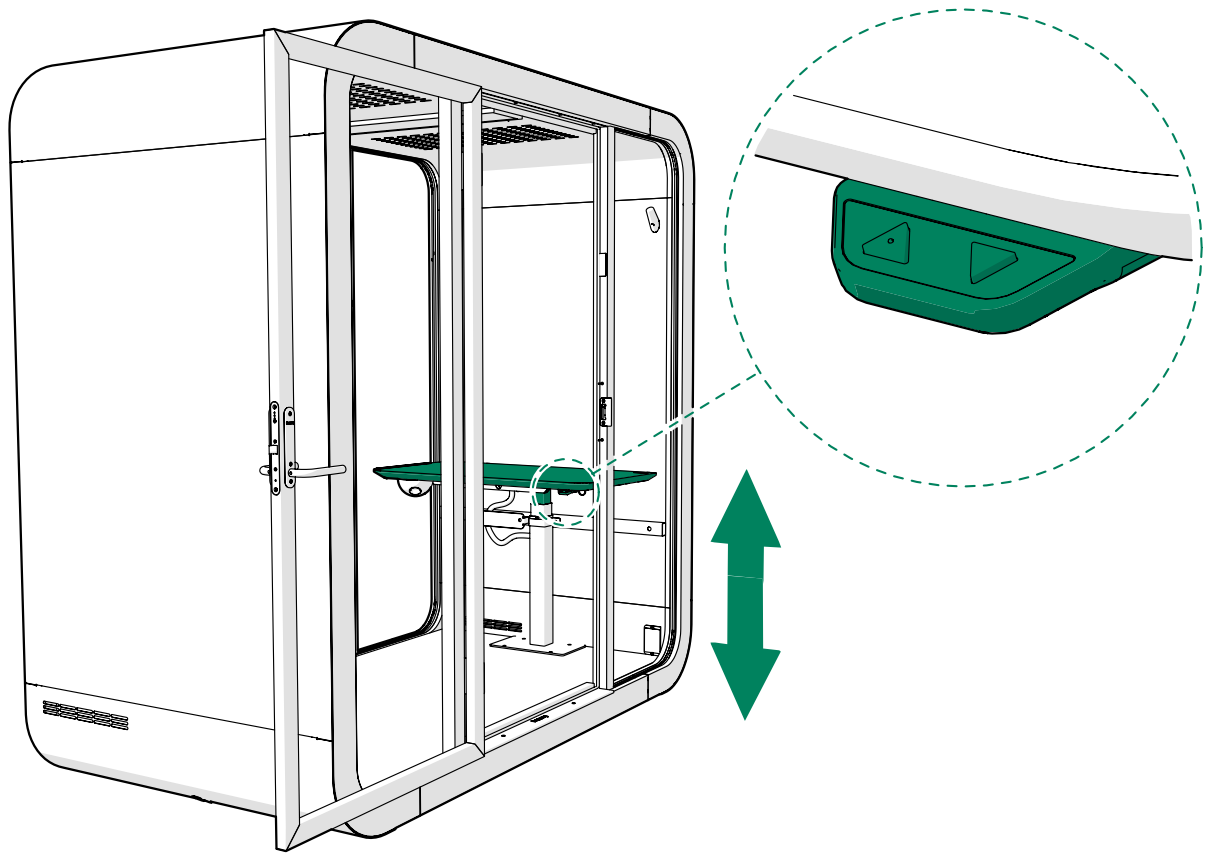

4 Using the control panel (Framery Q)

4.1 Adjusting the lights

1.

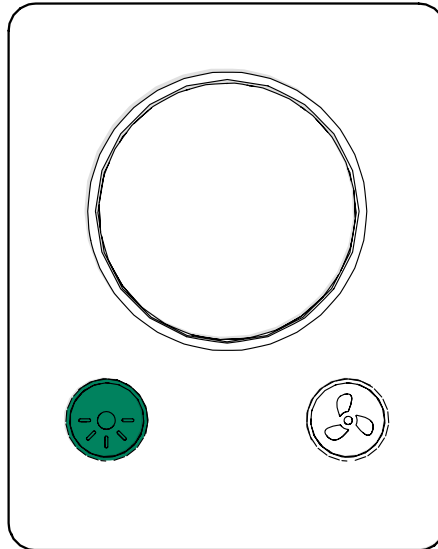

2.

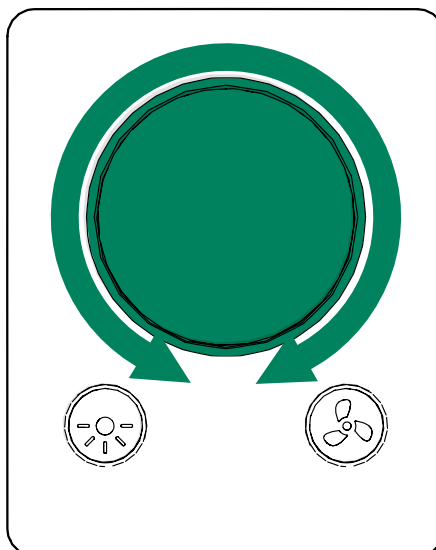

4.2 Adjusting the fans

1.

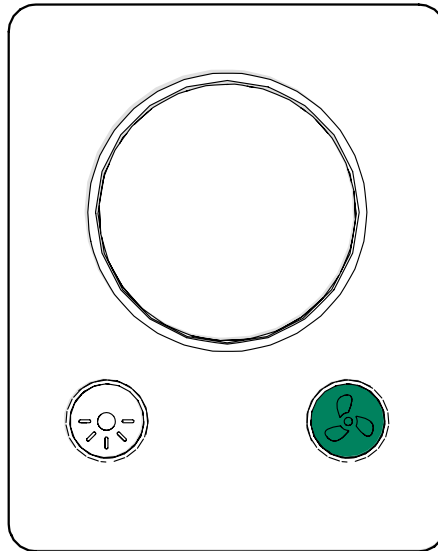

2.

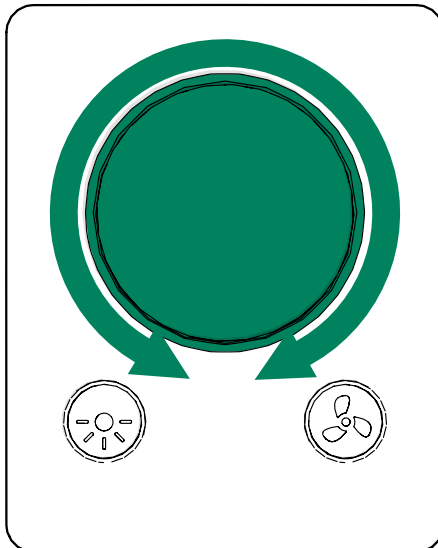

5 Connecting electrical equipment

 **Warning:** Do not connect any extension cords to the power outlet(s) of the product.

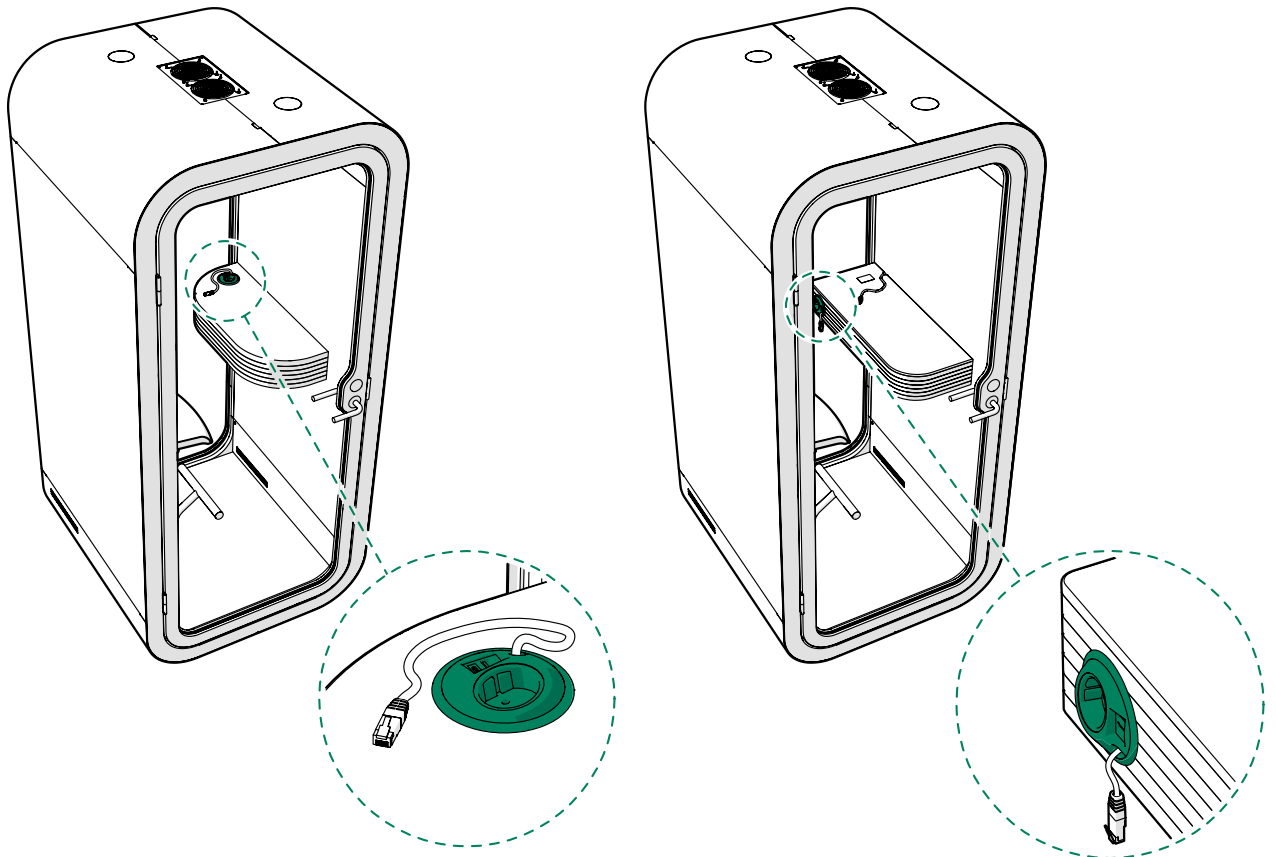

Figure 1: Power outlet in Framery O and Framery O with wide table

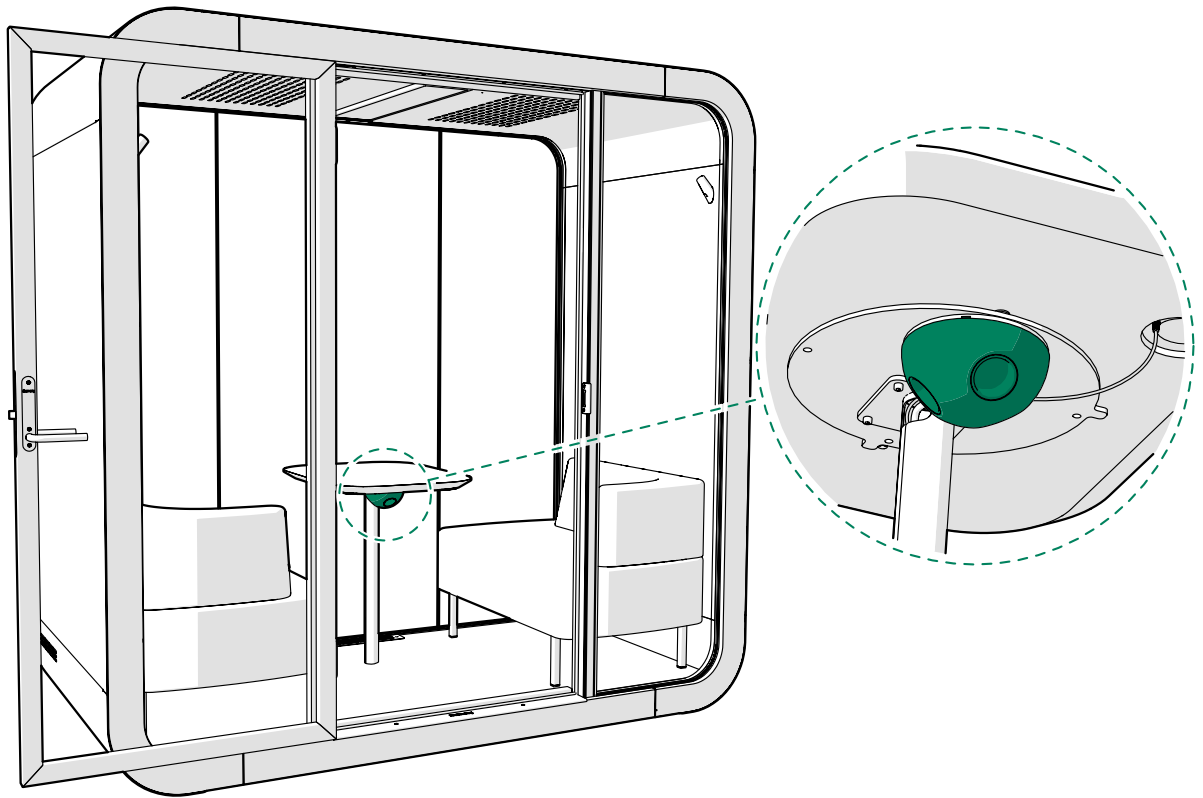

Figure 2: Power outlet in Framery Q Meeting Maggie

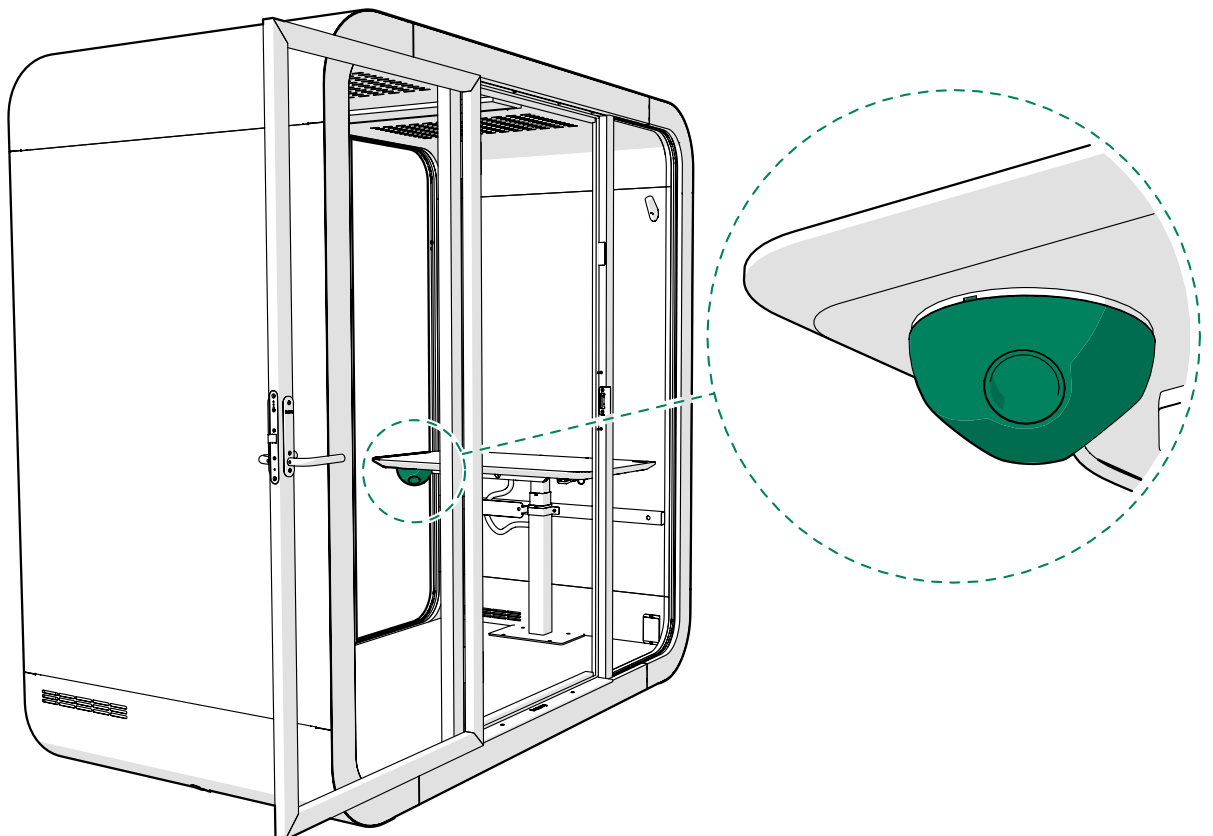

Figure 3: Power outlet in Framery Q Flow

6 Using the wireless charger

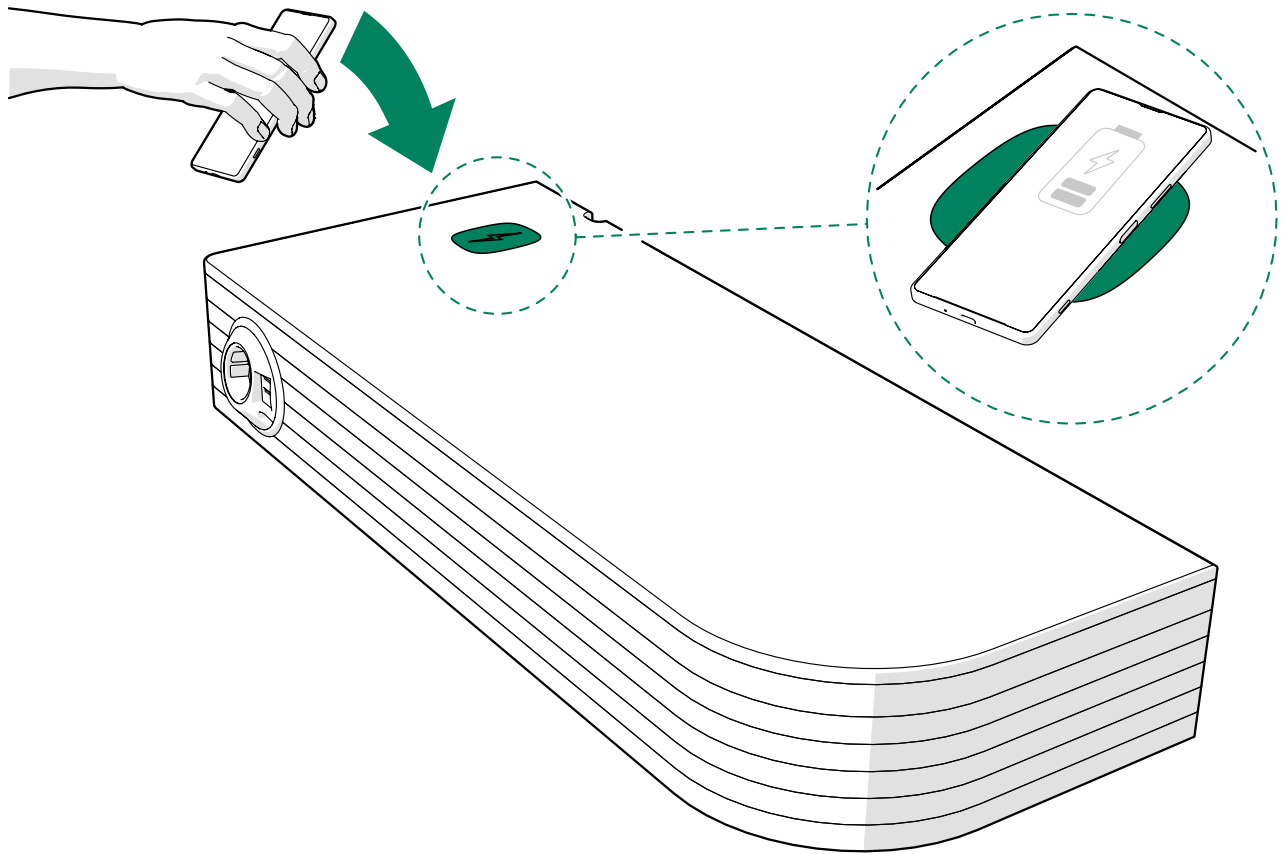

Figure 4: Wireless charger in Framery O

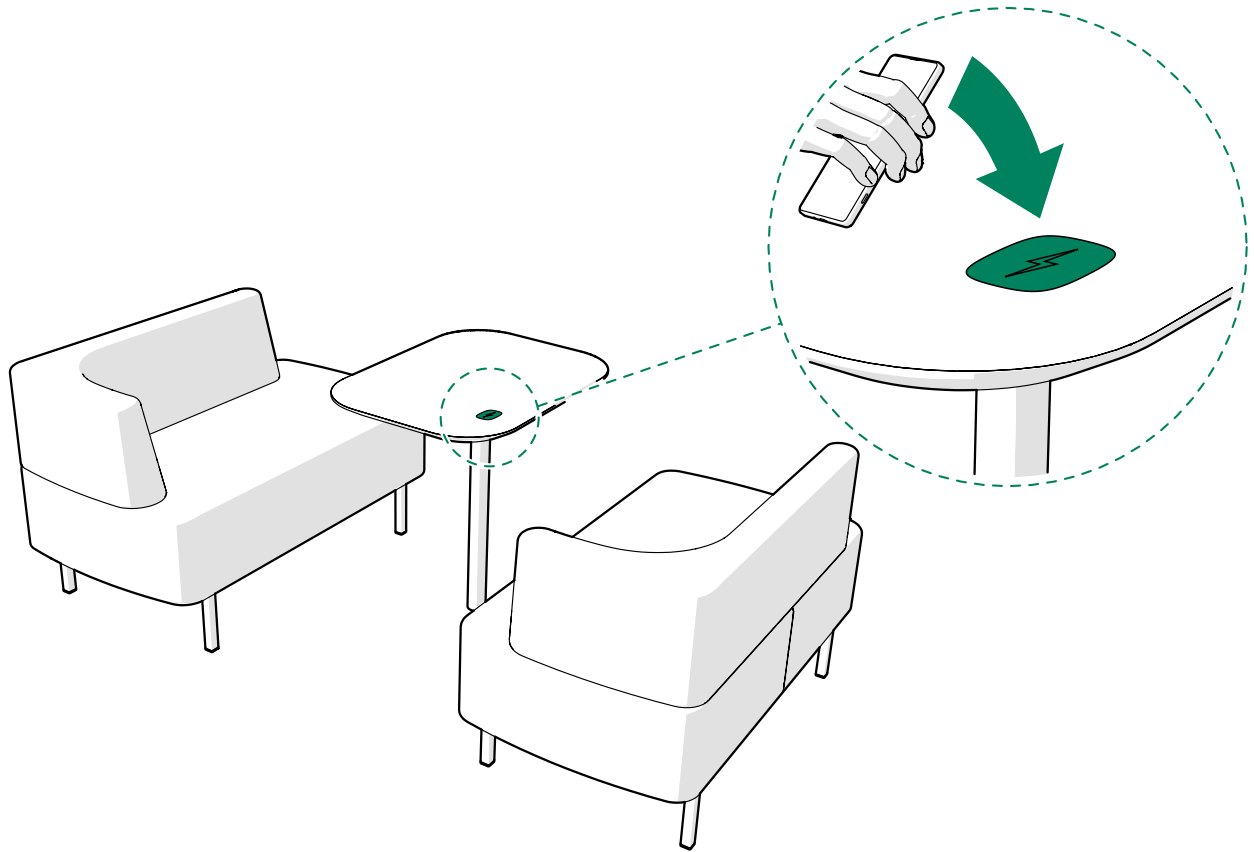

Figure 5: Wireless charger in Framery Q Meeting Maggie

7 Important safety and product instructions

7.1 Product information

The information in this manual corresponds to the product at the time of delivery. All information included in this manual is valid at the time of publication.

7.2 Copyright

This document must not be copied, presented, or delivered to a third party without explicit permission from Framery. The use of this document for any purpose other than those allowed by Framery is prohibited. Framery reserves the right to change the instructions related to the product without separate notice.

7.3 Intended use

The Framery O is a pod intended for short term indoor commercial and household use by one (1) person at a time.

The Framery Q is a pod intended for short term indoor commercial and household use by one to four (1-4) people at a time.

 **Warning:** WARNING –To reduce the risk of burns, fire, electric shock, or injury to persons:

Use this product only for its intended use as described in the user instructions. Do not use attachments not recommended by the manufacturer.

7.3.1 Non-conventional use

Any use or maintenance of the product that is not specifically allowed in the installation, maintenance, troubleshooting or user instructions is prohibited, including the following:

- Installation, maintenance or disassembly of the pod without reading and understanding the instructions for those actions
- Use of the pod beyond the limits of use
- Making alterations to the pod
- Using the pod in spite of obvious defects or damage
- Using the pod outdoors or in conditions where the temperature or air quality is not safe
- Climbing on top of the product or placing any load on the roof of the product
- Smoking in the pod

7.3.2 Ambient conditions for use

The pod is intended to be used in the following conditions:













- Ambient temperature: +15°C ... +30°C (59°F ... 86°F)
- Humidity: max. 50%
- Sufficient air quality surrounding the product

7.4 Main safety risks related to the installation, maintenance, disassembly, and use of the product

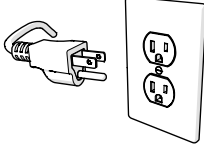
7.4.1 Electrical safety

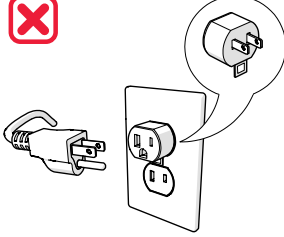
Input for the electrical system: 100-240 VAC (10 A) 50-60 Hz

The maximum load for the electrical system is 6.6 A.

	<p>DANGER!</p> <p>To reduce the risk of electric shock, obey the following:</p>
	<p>Disconnect the power cord from the power outlet before starting any cleaning, maintenance, or disassembly procedures.</p> <p>The power cord serves as a power disconnect device for pluggable equipment. The power outlet shall be located near the equipment and shall be easily accessible.</p>
	<p>WARNING!</p> <p>To reduce the risk of burns, fire, electric shock, or injury to persons, obey the following:</p>
	<p>Connect the power cord to a properly grounded outlet only.</p>
	<p>This product is for use on a nominal 120-volt circuit and has a grounding plug that looks like the plug illustrated in the figure below. Make sure that the product is connected to an outlet having the same configuration as the plug. No adapter should be used with this product.</p> <div style="display: flex; justify-content: space-around; align-items: center;"> <div style="text-align: center;">   </div> <div style="text-align: center;">   </div> </div>
	<p>Keep the power cord of the product away from heated surfaces.</p>
	<p>Do not use the pod if you notice any defects or damage to the electrical equipment.</p>
	<p>Do not connect any extension cords to the power outlet(s) of the product.</p>













7.4.2 Use





Framery O:

- Maximum load for the table is 131 lbs (60 kg).
- Maximum load for the Tovi Stool is 300 lbs (136 kg).

Framery Q:

- Maximum load for all Framery Q tables is 131 lbs (60 kg).
- Maximum load for the Meeting Maggie sofa is 600 lbs (272 kg).
- Maximum load for the display bracket is 22 lbs (10 kg).

	<p>WARNING!</p> <p>To reduce the risk of burns, fire, electric shock, or injury to persons, obey the following:</p>
	<p>Read and understand the user instructions before using the product.</p>
	<p> Note: The following statement applies to use in Japan.</p> <p>This equipment is not suitable for use in locations where children are likely to be present.</p>
	<p> Note: The following statements apply to use in all other countries.</p> <p>Close supervision is necessary when this furnishing is used by, or near children, invalids, or disabled persons.</p> <p>Keep children away from extended foot support (or other similar parts).</p>
	<p>Risk of injury! Keep hands and other body parts clear of the side edges of the table when raising or lowering the electrically adjustable table top. This applies to all Framery pods with an electric adjustable table.</p>
	<p>Do not use the product if the surrounding conditions are in any way hazardous; the air circulating inside the pod is derived from the surrounding space.</p>
	<p>Do not use the product if the ventilation is not functioning.</p>
	<p>Do not use the product if the ventilation channels are blocked. Keep the ventilation channels free of lint, hair, and the like.</p>
	<p>Do not use the pod if you notice any defects in the electrical equipment or if the product is not working properly. Disconnect the power cord from the power outlet and contact your local dealer or the manufacturer immediately.</p>
	<p>Do not drop or insert any object into any opening if not specifically instructed to do so in this manual.</p>
	<p>Do not use outdoors.</p>

	<p>Do not use where aerosol (spray) products are being used or where oxygen is being administered.</p>
	<p>Do not climb on top of the product or place any load on the roof of the product.</p>
	<p>Do not lean against the product.</p>
	<p>Do not smoke inside the product.</p>
	<p>Do not obstruct the view through the front and back glasses by posting signs, decorations, or by installing blinds or draperies that would prevent occupants from seeing the visible alarm appliances located in the structure where the pod is installed.</p>

framery

Framery pods
User instructions
Patamäenkatu 7
33900 Tampere
FINLAND
VAT: FI 23527139